

User Manual

Milli-Q® EQ 7000



Table of contents

INTRODUCTION	1
System overview	2
LEDs overview	4
QUICK START	5
Exit screensaver	5
Dispense ultrapure water	5
Water Quality values	6
Dispense archiving	6
View & manage Alerts and Alarms	7
Navigate the screen interface	8
CONSUMABLE MENU	10
SETTINGS MENU	11
Manager access & password	12
System configuration	13
HMI configuration	13
Accessories	14
Alarm set points	15
Connectivity	15
Date Time & Language	16
Units	17
INFORMATION MENU	18
System	18
History	18
Flow schematic	19
Troubleshooting	19
Contacts	19
MAINTENANCE MENU	20
Depressurization	20
Consumable installation wizards	20
Cleaning & Sanitization	22
UV lamps	23
SELF HELP GUIDE	24
Depressurize system	24
Turn system off	24
Inaccurate volumetric dispensing	24
High TOC values	24
Low flowrate	25
IPAK & other cartridges installation	25
REQUIREMENTS AND SPECIFICATIONS	27
Water specifications	27
System specifications	28
Dimensions and weight	29
Recycling	30
Ordering Information	31
LEGAL INFORMATION & WARRANTY	32

INTRODUCTION

Congratulations!

Thank you for buying a Milli-Q® water purification system.

Milli-Q® EQ 7000 produces ultrapure water from a purified water source. Installation of this product should be performed by a qualified service representative with access to qualified installation documentation.

This user manual is a guide for use during the normal operation and maintenance of a Milli-Q® EQ 7000 water purification system. It is highly recommended to fully read this manual and understand its content before handling the water purification system.

System identification

System	Catalog number	Voltage	Frequency
Milli-Q® EQ 7000 Water system (includes HMI)	ZEQ7000T0C	100-240 Vac ±10%	50-60 Hz ±2Hz

Manufacturing site:

Millipore SAS, 67120 Molsheim, France

For more information on your Milli-Q® system, please call your local representative or visit our website www.sigmaaldrich.com

Intended use

The Milli-Q® EQ 7000 is intended to produce ultrapure water from a purified water source primarily for use in a variety of laboratories worldwide.

The product is designed to produce ultrapure water with specific characteristics (refer to the requirements and specifications section), provided that it is fed with water quality within specifications and it is properly maintained as required by the supplier.

We do not warrant the product for any specific application. It is up to the user to determine if the quality of the water produced matches their expectations, fits with norms/legal requirements and to bear responsibility resulting from the usage of the water.

The product is not intended to produce: water for injection, water for dialysis, sterile water for irrigation or injection, bacteriostatic water for injection, sterile purified water in containers, and sterile water for injection in container or ingestion. The product is not intended to be used in explosive environments according to ATEX Directive – equipment & protective systems intended for use in potentially explosive atmospheres. In addition the product is not intended as a Medical Device, including In-Vitro Devices.

System overview

Milli-Q® EQ 7000 consists of 3 main parts:

Q-POD® unit
(Point Of Dispense)

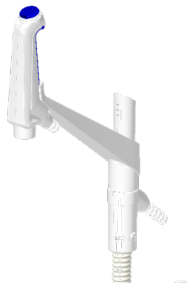

Water purification unit



HMI
(Human Machine Interface)



Mounting options of the system

The Milli-Q® EQ 7000 offers 2 configuration and 2 installation options (options can be mixed):

Benchtop solution



with Benchtop options

Wall-mounted solution



with Wall-mounted options

Description of the system

The Milli-Q® EQ 7000 manages the production and the distribution of ultrapure water from a purified water source such as a tank or a pressurized loop. It consists of three main units:

- The water purification unit manages the production of ultrapure water.
- The Q-POD unit manages the dispensing with Quick info for the performance of the system through LEDs.
- The HMI unit provides the user interface.

Purified water either from a pressurized loop or a storage tank enters the purification unit. It is first purified by the IPAK Meta® polishing cartridge composed of ion-exchange resins, removing the bulk of the ions. The purified water then flows to the UV 185nm oxidation lamp. Organic molecules are partially oxidized, resulting in ions. These can then be captured in the next stage when the purified water enters the IPAK Quanta® polishing cartridge, composed of ion-exchange resins and synthetic activated carbon. The IPAK Meta and IPAK Quanta polishing cartridges always need to be replaced together to ensure optimal purification down to trace levels of contaminants. Throughout the purification steps, quality parameters are monitored with resistivity and temperature sensors and the TOC (total oxidizable carbon) indicator. The TOC indicator gives an indication of the total organic content measured in ppb at the point of distribution.

The Q-POD dispenser is detachable from its support. Its dispensing 'wheel' delivers water at 3 different flows: Low - Medium - High, up 2 L/min.

At the outlet of the dispenser, the final purification is performed by the application-specific POD-Pak. The large 7" touchscreen on the HMI offers a wide range of applications for users. It also has a USB port to easily export data.

Note: High flow reaches above 2L/min when attached to a pressurized loop

When not in active use, the water within the system will recirculate for three minutes every hour. This is to maintain a clean environment and to avoid contamination. The system should not be turned off as this will stop the periodic recirculation taking place.

System flow schematics

The system can be fed either by a pressurized loop or a storage tank.

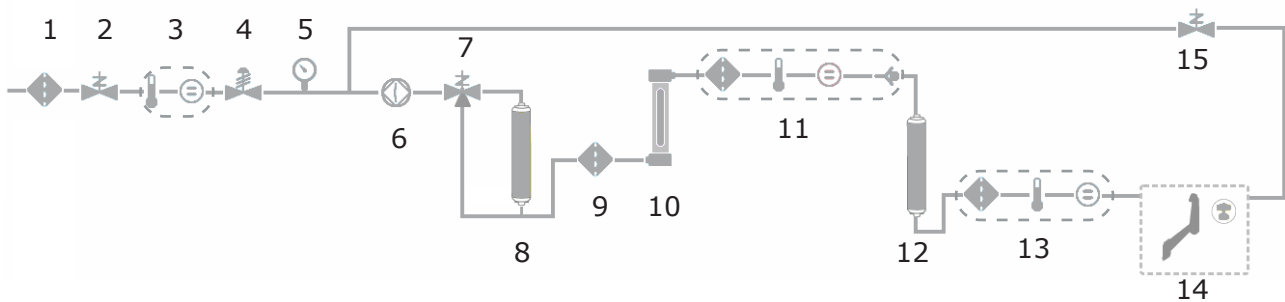

1	Inlet strainer	9	Strainer
2	Inlet valve	10	UV lamp 185mm
3	Feed Conductivity Cell (option)	11	Intermediate resistivity cell
4	Internal Pressure Regulator (option)	12	IPAK Quanta® Cartridge
5	Pressure Sensor	13	Product resistivity cell
6	Pump	14	Point Of Dispense (POD)
7	3-way valve	15	Recirculation valve
8	IPAK Meta® cartridge		

LEDs overview

On the Q-POD® unit, 3 LEDs indicate the different states of the system:

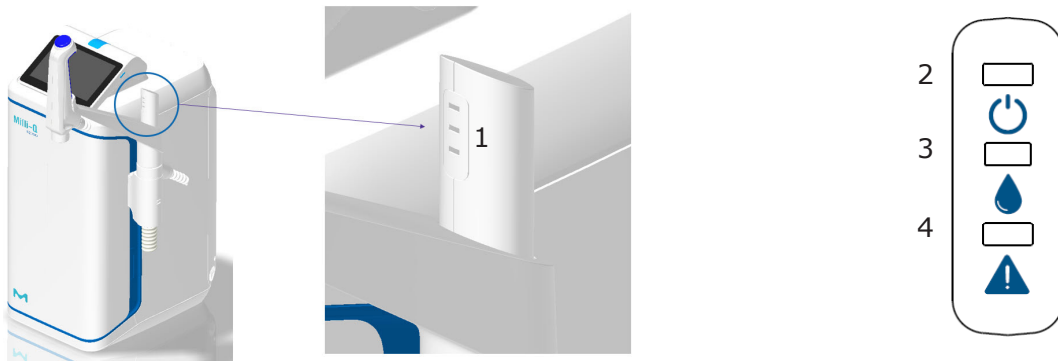

1	LED on the Q-POD arm	3	Water Quality LED
2	System Power LED	4	System Alarm / Alert LED

LEDs description

LED	Meaning
	The system is powered on
	STEADY: The water quality fits the requirements (water quality values are below alarm setpoints) BREATHING: The system is in recirculation mode
	A water quality alarm is raised
	An alert or alarm is raised
	An high importance alarm is raised: the system is stopped for safety reason

Note:

- The 3 LEDs light up when powering the system on.
- The 3 LEDs are breathing in case of maintenance (see page 20)

QUICK START (after installation performed by a qualified Field Service Representative)

Exit screensaver

If the setting is active and there has been a certain time of user inactivity, the screensaver will be displayed on the HMI touchscreen.

Screensaver

Tap anywhere on the screen or initiate a manual dispense by pressing the dispenser wheel to exit the screensaver.

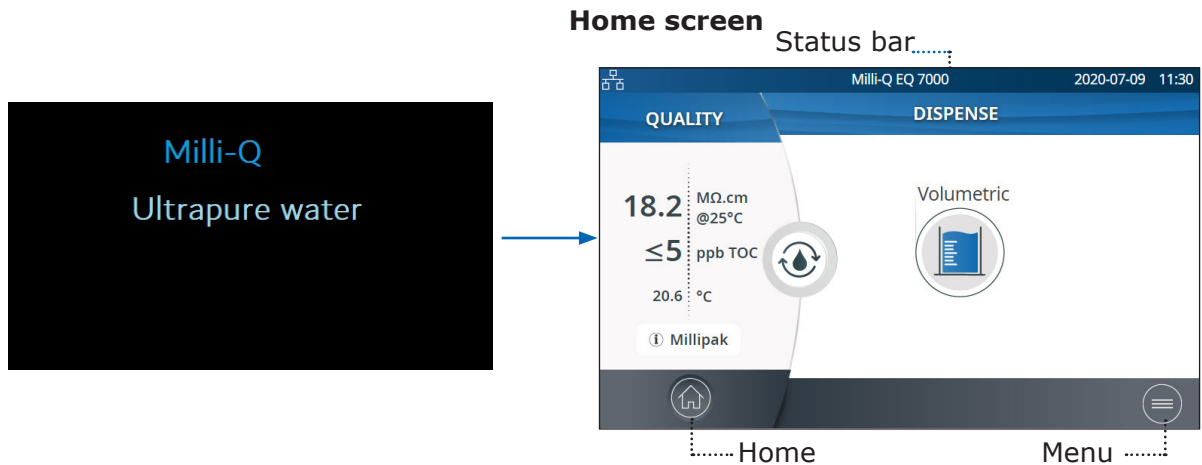

Dispense ultrapure water

It is a good practice to always recirculate water before dispensing. To do this, press on the recirculation icon, this also refreshes the water quality parameters:

- Product resistivity
- TOC
- Temperature

Recirculate



There are several options to dispense ultrapure water:

Manual Dispensing

To start dispensing in low flow, turn the dispense wheel one notch counter-clockwise.

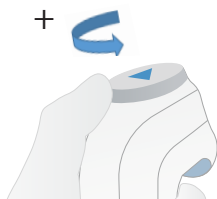

Adjust flowrate

To increase the flow rate keep turning the wheel counter-clockwise until full flow is reached. To decrease the flow rate, turn the wheel clockwise.

Low flow  Full flow 



To start dispensing at full flow, press down on the wheel.

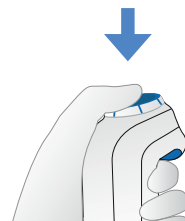

Stop

To stop any ongoing dispensing, press down on the wheel or rotate the wheel clockwise until no more water flows from the dispenser.



Volumetric Dispensing (100mL to 10L)

Enables a user to auto dispense a pre-selected volume.

Note: When connected to a storage tank, always make sure there is enough water present before dispensing. This information is always displayed in the status bar:



Select the volume to dispense, press ok to validate. The input value can be customized, go to page 14 [Settings > System configuration](#)

Press the Play button to start dispensing the pre-selected volume.



The system will automatically stop once the requested volume is reached.

Water Quality values

When the dispensing is finished, the resistivity and temperature are instantly displayed on the left side of the HMI. Ninety seconds later a new TOC value at the point of distribution is indicated.



The corresponding LED lit green if the water quality fits the requirements.

If the calculated TOC value is from 0 to 5 ppb, ≤ 5 ppb will be displayed

If the calculated TOC value is from 6 to 10 ppb, ≤ 10 ppb will be displayed

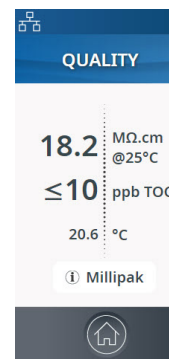

For values upper to 10 ppb, a rounded value will be displayed.

Dispense archiving

Water quality values of each dispense are automatically archived and can be retrieved in the history report section available in the information menu. Go to page 10 [Information > History](#) for further information.

View & manage Alerts and Alarms



Alerts give you advanced warning when maintenance is required and Alarms notify you when the system has encountered a technical issue.



▲ Yellow LED is displayed when an alert is raised.



▲ Red LED is displayed when an alarm is raised.

Press on the alert  or the alarm  icon present in the bottom bar to display the alert(s) or/and alarm(s) which are active.

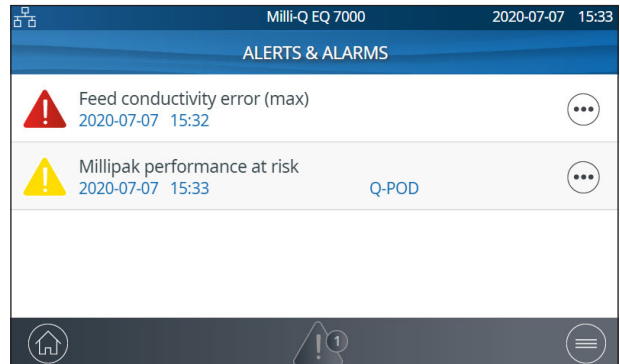

Note: The notification number indicates how many active alarms are present. When there are no active alerts or alarms, the icon disappears.

Select a specific alert or alarm to get further information and better understand the root cause. Advice is provided in the **Information** tab to help the user troubleshoot.

If the issue is not resolved, select the **Contact** tab to find the technical support hotline number for further assistance.

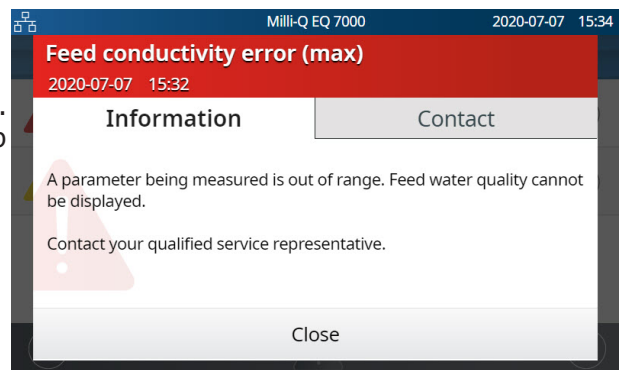

To protect the system and user applications, high-importance alarms will automatically stop the system from dispensing water.

Note: These are displayed on the screensaver to alert the user when the system is not in active use.

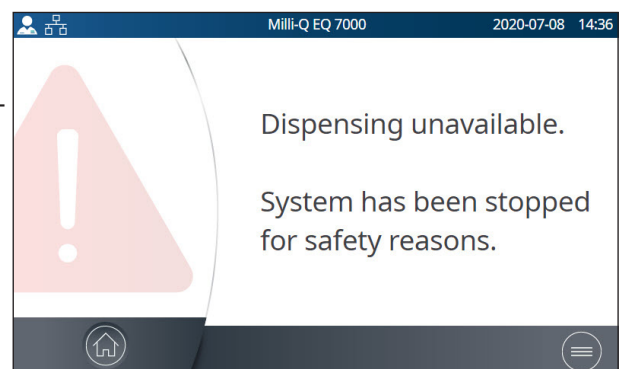

Alerts provide advanced warning of any maintenance actions that will be required. These can be "closed" to be reminded again in 24h or can be "cleared" permanently.

An **Order** tab will be present containing ordering information when applicable.

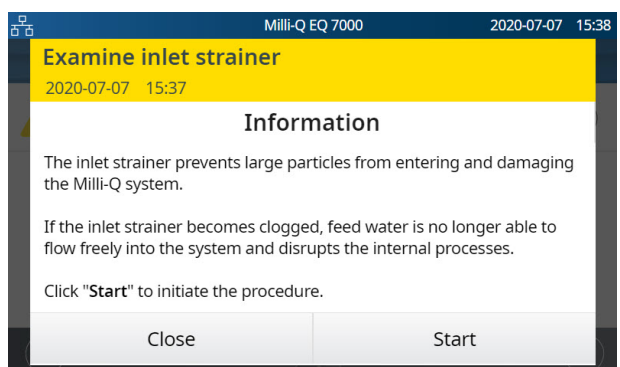

Navigate the screen interface

The HMI 7" touchscreen allows the user to control and monitor the water system. All sub-menus and applications can easily be reached in a few clicks or swipes, similar to a smartphone.

HOME SCREEN

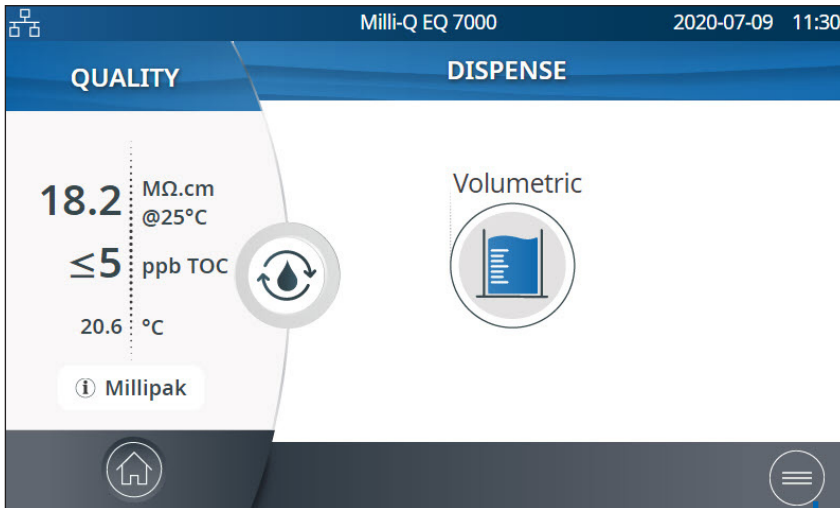

Home

- Water quality information
- Dispensing function
- Alerts & Alarms (when applicable)

MAIN MENUS



Menu

- Consumables
- Information
- Settings
- Maintenance
- Login

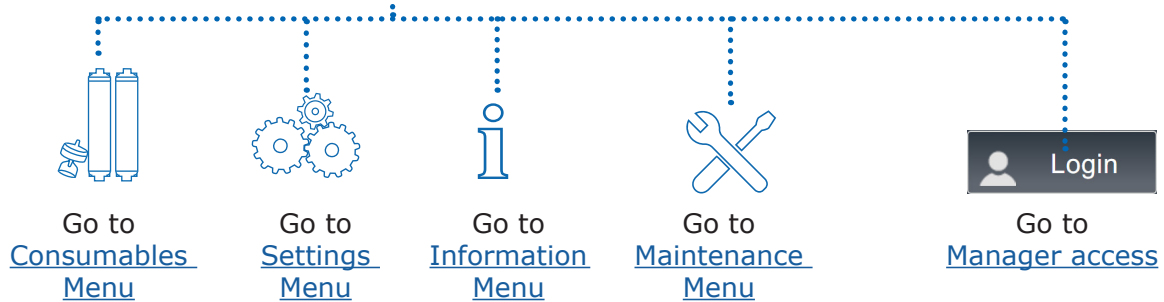

Apps

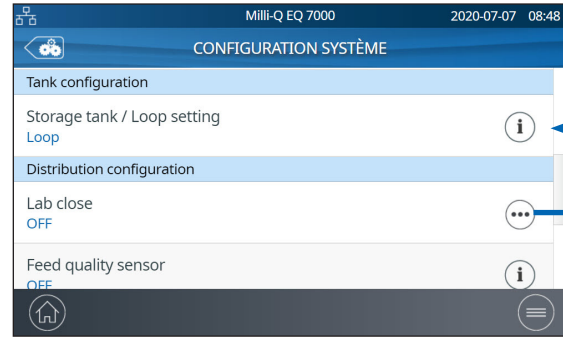
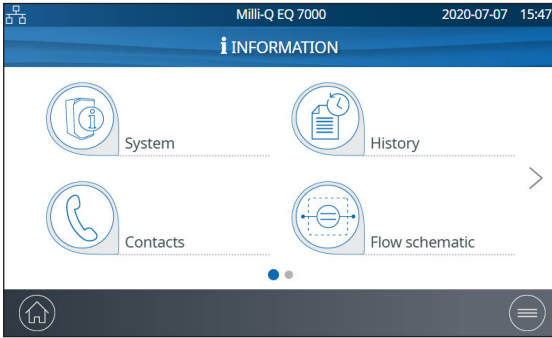

When there are multiple lines, a scroll bar is present to swipe up & down



Indicates how many screens are present and where you are.

Swipe left & right anywhere on screen to switch between screens.

Pops-up

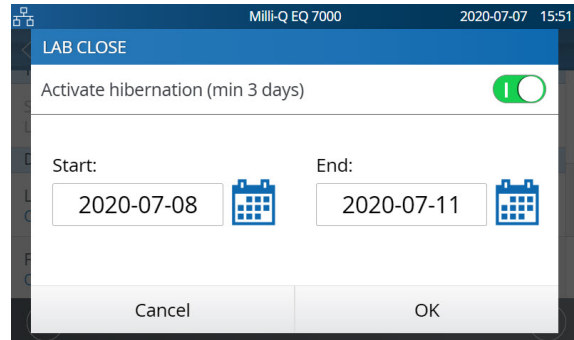
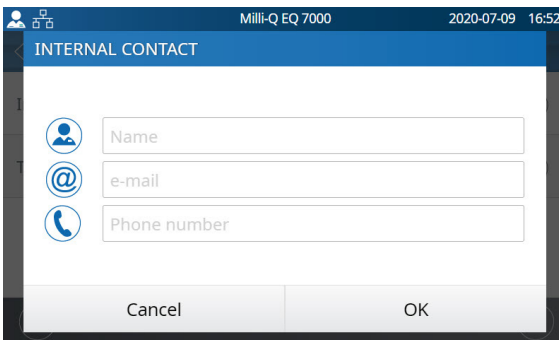

When you click in a zone of text, the keypad will automatically appear.

To remove the keypad click on  or on any zone outside the keypad.



Note: When in a menu or app level screen, 1 minute of inactivity generates a timeout back to the home screen.

When in a pop-up level screen, there is no timeout, therefore the user remains on this screen until the pop-up is manually closed.

CONSUMABLE MENU

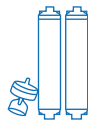

Viewing Consumables Status

Color icons and color LEDs allow to instantly view the status of all installed consumables.

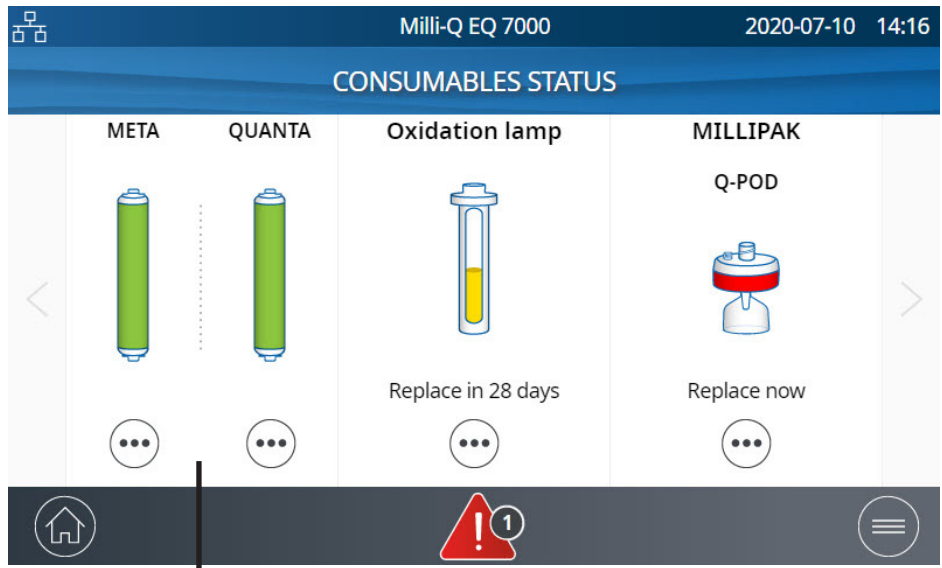

LEDs



- Green:** no action required
- Yellow:** notice for a maintenance action
- Red:** maintenance required!

Press on the  icon to get the consumable ID, ordering information and a description of the purification technology.

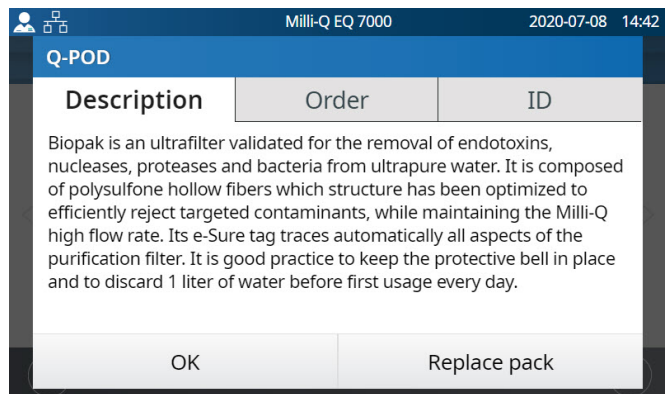

Note: Certificates of quality are now available online www.mymilliqconsumables.com

All cartridges have been designed to be easily replaced by a user. A shortcut is available to the replacement wizard by clicking on the "replace pack" button in the pop-up.







SETTINGS MENU



Different settings are available to customize the water purification system operation. Depending on the user profile (end-user operator / system manager) some of the settings will have either read-only or read & write access ✓.

Settings		End-user	System Manager
System configuration	Lab close	✓	✓
	Recirculation	Read only	Read only
	Safety stop	Read only	✓
	Foot pedal	Read only	✓
	Screen saver	Read only	✓
	Tank/Loop setting	Read only	Read only
	Water sensor	Read only	✓
	Feed quality measure	Read only	✓
	Alarm relay activation	Read only	✓
	Alarm relay configuration		✓
	Custom Volume	✓	✓
HMI configuration	Brightness	✓	✓
	Buzzer	Read only	✓
Alarm configuration	Product resistivity	Read only	✓
	Product TOC	Read only	✓
	Inlet strainer clean	Read only	✓
	IPAK Polishing cartridges		✓
	Millipak		✓
	Millipak Gold		✓
	LC-Pak		✓
	VOC-Pak		✓
	EDS-Pak		✓
	LC-Pak 0,1µm		✓
0,1µm Pak		✓	
Connectivity	Local network	Read only	✓
Date, Time & Language	Time zone	Read only	✓
	Date	Read only	✓
	Time	Read only	✓
	Language	Read only	✓
Password	Activate / Change password		✓
Units	Resistivity / Conductivity	Read only	✓
	Temperature	Read only	✓
	Tank volume	Read only	✓
	Temperature compensation	Read only	✓
	Pressure	Read only	✓

Available apps:

 System Configuration	 HMI Configuration	 Date, Time & Language	 Password
 Alarm Configuration	 Connectivity	 Units	

Note: Dispensing while in this menu is not available.

Manager access & password

Login as a Manager

1. Press on the menu button  from the Home page.

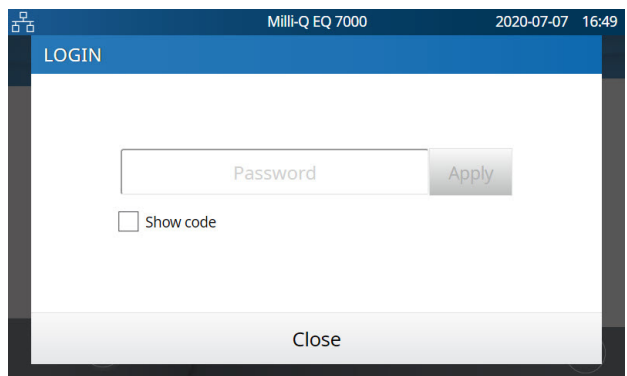

2. Press on Login:.....
3. Enter system manager password.

To display & see the password while typing, click on the "Show code" checkbox.

Once logged-in, the manager icon  is displayed in the top left corner.

If a manual logout is not performed, the system manager profile will be automatically logged off after 1 hour.

Note: By default this parameter is activated. The default password is **PASS**
If the system manager password is forgotten, contact the technical support hotline.

Log off as a Manager

1. Press on the menu button .
2. Press on "Logout".

Modify system manager settings

This can only be done when logged-in as a manager.
In the **Password** app:

1. Deactivate/re-activate the manager password through the password activation slider button.
2. If required, change the password.

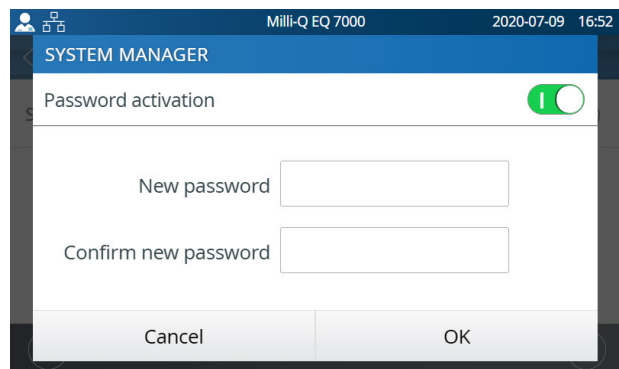

Important! Deactivating the system manager profile will allow any user user to have read & write access on all settings.

System configuration

Lab close

When leaving the lab for long periods of inactivity, this mode can be activated to save energy and reduce wear of system components. Recirculation is reduced to once a day. When it is 24 hours prior to resuming lab activity, the system automatically resumes a recirculation every hour, ensuring it is ready for use.

1. Activate Lab close via the slider button.
2. Enter a Start and End date (minimum of 3 days). Lab close mode will be initiated at 00:01 on the selected date.

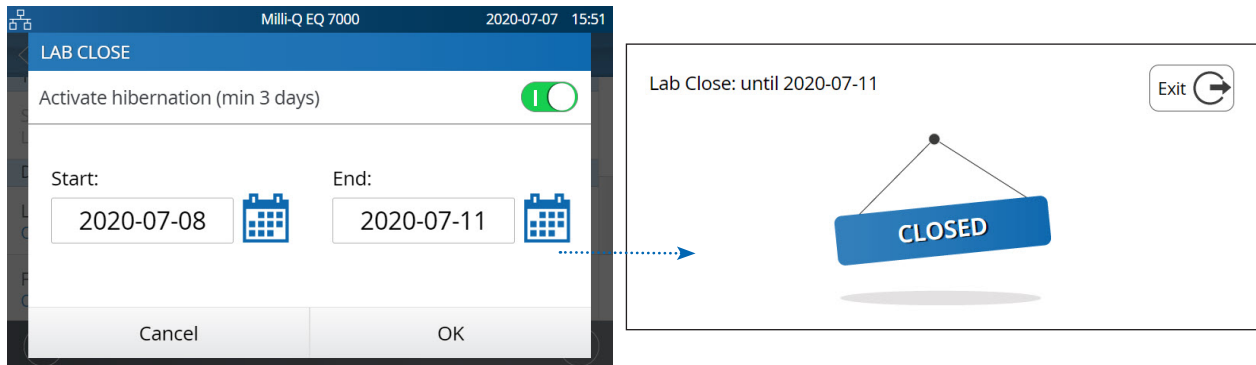

Safety flow stop

A precautionary measure that stops a Q-POD dispensing after having continuously delivered water for a certain duration.

Adjust to the preferred time by using the arrows or click on the box to access the keypad.

By default the timer is set to 15 minutes and is active. This setting will not impact volumetric dispensing functions.

Screensaver

This is the maximum duration of inactivity on the HMI before the screensaver starts.

1. Activate / deactivate via the slider button.
2. Adjust to the preferred time by using the arrows or click on the box to access the keypad.

By default the screensaver is active and the timer is set to 5 minutes.

Custom Volume

This is the volume you can customize to be able to dispense with the Volumetric Dispensing function.

The volume can be set from 100 to 25000 mL in 100 mL increments.

HMI configuration

This app allows a user to configure all parameters specific to the HMI.

Screen brightness

Adjust to the preferred brightness from 1 to 7 using the arrows or click on the box to access the keypad and type-in the value.

Buzzer

The POD can emit a sound when alerts/alarms are triggered. This can be activated or deactivated using the slider button. By default, the sound is deactivated.

Accessories

Water sensor

A water sensor can be connected to the system unit to stop the system from producing water in case of water spillage.



Foot pedal

The pedal is connected to the system.

In the HMI configuration app, activate the foot pedal via the slider button.

Dispense using the foot pedal

1. Press once and release to dispense in full flow.
2. Press once to stop the flow dispensing.



Feed water conductivity sensor

A conductivity sensor can be installed inside the system to monitor the feed water quality entering the system from the loop. If bad water quality is detected, an alarm that stops water production will appear, informing the user that the system is at risk and to check the feed water quality. This will protect the downstream purification technologies in case of a problem. This accessory is not meant to be used with deionised feed waters.



Inlet Pressure Regulator

This accessory will allow to regulate the pressure of the water entering the system from the loop. This will protect the downstream elements from high water pressure. It is highly recommended to use this regulator instead of an external pressure regulator on the feed water tubing.



Alarm relay

This accessory will allow to relay all, or a selection of alarms to a remote device.

Select the alarm(s) that will activate the relay.

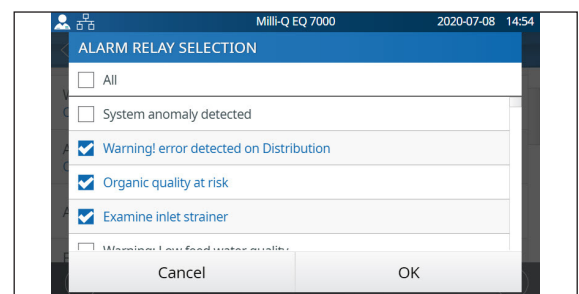

Alarm set points

Adjust the alarm set points by either clicking on the arrows or alternatively, click in the box to access the keypad and directly type-in the value.

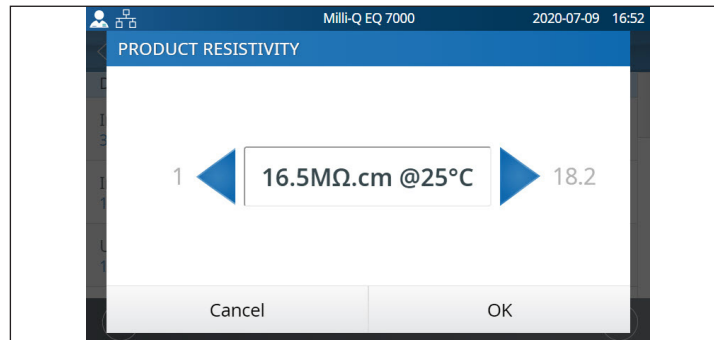

Water quality

- Product resistivity/conductivity
- Product TOC

Inlet strainer clean

This is only applicable when set-up in Loop configuration. It is recommended to clean the inlet strainer once a year to avoid clogging. Depending on the feed water and its particle concentration, the inlet strainer clean frequency can be adapted.

Cartridge lifetime

Cartridges should be changed when the system alerts the user.

Saturated pack will start to let ion and organic contaminants through. This is called breakthrough and often starts with traces that cannot be detected by on-board monitoring. Some technologies will clog, creating a back pressure which can result in flow-rate issues.

In validated settings, to adjust lifetimes according to existing SOPs, click on the applicable filters and adjust accordingly.

- IPAK polishing cartridges
- POD-Paks

Connectivity

The system offers the possibility to be connected to a laptop with a fixed IP address or to your local network (DHCP protocol/fixed IP address) via an Ethernet port. The IP address of the system can be seen by swiping the screen top to bottom.

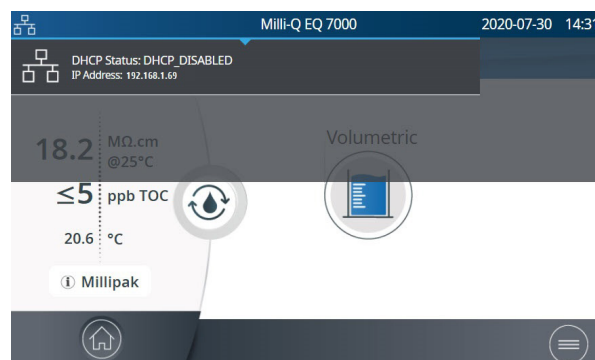

The DHCP (Dynamic Host Configuration Protocol) is an “automatic configuration” of a device anytime it connects to an IP Network. This “automatic configuration” is called allocation. The system is automatically recognized and an IP address is assigned to it, and configured so that the network resources can be used. Check with your local IT resources which type of connection is best suited to you.

Change network connection settings

1. For a direct connection, change the network settings if necessary (default IP address: 192.168.1.69).
2. For network connection, activate DHCP via the DHCP activation button.

Duplicate user interface in a browser

Once connected:

1. Go to your browser. For best browsing performance, Chrome® is recommended.
2. Enter the IP address of your system which can be found in the connectivity pop-up screen.

Note: The view from a laptop enables a user to view the HMI display remotely. Dispensing operations cannot be conducted remotely for safety reasons.

Date Time & Language

The norm ISO® 8601 has been used as a reference for a standardized way of presenting dates and times.

Date

Calendar date representations are shown in the form “2020-07-06” [YYYY-MM-DD]. [YYYY] indicates a four-digit year. [MM] indicates a two-digit month of the year, 01 through 12. [DD] indicates a two-digit day of that month, 01 through 31.

Start by setting the year:

1. Click on the *month & year* title, this displays months and only the year as a title. Click again on the *year* title to display years.
2. Select the year, this then displays months.
3. Select the month, this then displays the days.
4. Finally select the day to confirm the date setting.

Time ZONE

1. Select the continental or oceanic zone you are in on the left. This updates the right-hand side with all the major cities within this time zone.
2. Select the appropriate city. If you have not found a city, make sure you are in the right time zone.

The Milli-Q® system is now configured to display current local time and automatically updates when daylight saving time applies.

Time

The time is set and displayed in a 24h clock format. A time of day is written in the 24-hour notation in the form hh:mm (for example 14:23), where hh (00 to 23) is the number of full hours that have passed since midnight, mm (00 to 59) is the number of full minutes that have passed since the last full hour.

Language

There are 9 languages available: Chinese / English / French / German / Italian / Spanish / Portuguese / Japanese / Russian

Units

Units can be formatted to local needs:

Resistivity / Conductivity	MΩ.cm	μS/cm
Temperature	°C	°F
Storage tank level	L	%
Pressure	Bar / kPa / psi	

Select and press on the unit of interest. The selected unit will appear in blue. Press "OK" to confirm selection and exit the pop-up.

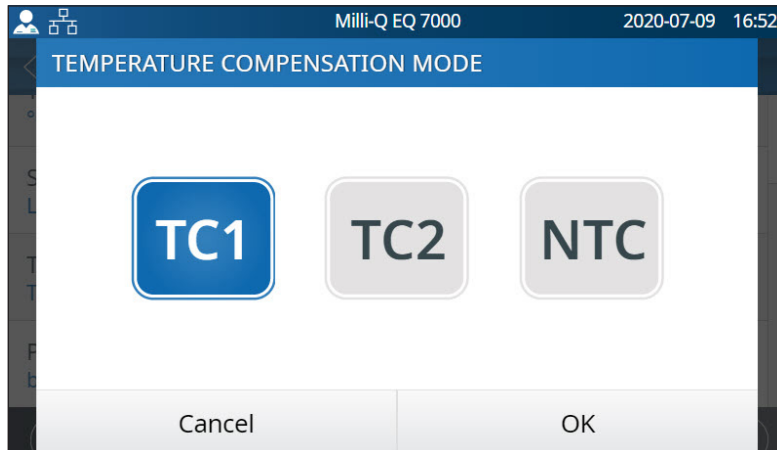

Temperature compensation mode

It is possible to show non-temperature compensated resistivity or non-temperature compensated conductivity. Temperature compensation is a way of standardizing resistivity or conductivity to measurements that would be seen if the water temperature was 25°C.





Select the preferred mode among the 3 modes of temperature compensation available:

TC1	<p>By default TC1 mode is selected.</p> <p>The resistivity or conductivity values are temperature compensated to 25°C. The values are normalised. The system firmware eliminates small fluctuations of temperature compensated resistivity or conductivity due to the fact that these two parameters are not measured exactly at the same time.</p>
TC2	<p>The actual temperature compensated resistivity or conductivity values are displayed. The TC2 setting should be used in applications that require the detection of trace ionic levels or when performing the verification of the system resistivity meter operation with an independent calibrated resistivity meter. In some operating conditions the feed water can be warmer or cooler than the water temperature inside the system. As a result, this can cause small fluctuations of the resistivity and conductivity values. Resistivity values could fluctuate between 18.0 Mohms.cm and 18.4 Mohms.cm @25°C while the actual resistivity is 18.2 Mohms.cm @25°C.</p>
NTC	<p>Non Temperature Compensation. The temperature compensation is off. The displayed resistivity or conductivity is not temperature compensated. The temperature of the water is shown at the same time as the non-temperature compensated resistivity or conductivity value.</p>

INFORMATION MENU

This menu contains useful system information and provides a system status. Dispensing is available while in this menu.

Available apps:

 System	 History	 Troubleshooting
 Contacts	 Flow schematic	

System

Find system details

Select *System ID* to find the information on the water system model and installation details.



History

2 user reports exist:

- [Daily quality measures report](#)
Each row represents a day (24h) and is dated. It contains daily averages for product resistivity, temperature and TOC. Also included is the total volume dispensed during the day.
- [Dispensing events report](#)
Each row is a dispense operation. It is an archive of all the dispense reports.

To export data or preview a graph:

1. Select a time period of interest with a start and end date.
2. A graph pre-view of the last 30 records is available on the HMI screen.
3. Export the report in .ods (open document source) format to visualize the full data and integrate them into a data management system.

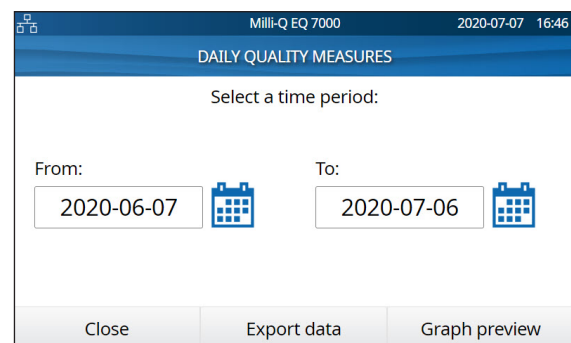

Note: A complete history report with all system activity is available. By default it is only available when logged-in as the system manager. This can be modified by de-activating the system manager profile in the settings menu, go to page 13 [Settings > Manager access](#).

Flow schematic

This is a graphic representation of the hydraulic components of the water purification system. Components change color depending on the state and system status.

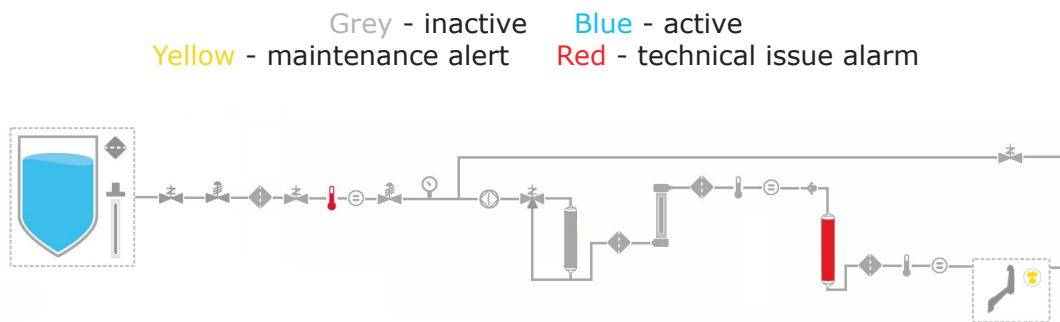

Troubleshooting



Access a diagnostic summary.

This app contains all the necessary information in one location for effective troubleshooting when in contact with the technical support hotline.

- System information & last service visit
- Water quality & consumables (installed dates)
- Active alerts, alarms & autotest results
- Diagnostics

Contacts

To edit contact information, login as the system manager, go to page 13 [Settings > Manager access](#). The user parameters are used on various reports generated by the system and can quickly help users identify the right contact for any questions or issues.

Technical support hotline In case of troubleshooting

Internal contact Responsible for the system inside your company

MAINTENANCE MENU



The maintenance of the system is easy thanks to the step-by-step instructions contained in the wizards. In addition, a new cartridge design means that pack removal and installation in the system unit is quick and effortless.

Available apps:



Note: Dispensing in this menu is only available in the applicable wizards.

Maintenance screens



Maintenance ongoing from the HMI.

Depressurization

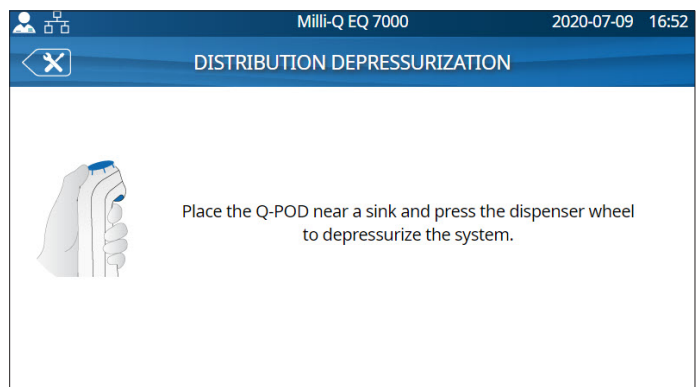

This temporarily stops production and all water processes.

This function is not necessary during normal system operation. See [self help guide section](#).



Consumable installation wizards

A maintenance wizard can be accessed in different ways:

1. Through the Maintenance menu 
2. A shortcut from an Alert  or Alarm  pop-up
3. A shortcut from a consumable pop-up

IPAK Meta and IPAK Quanta replacement

1. Select **Install consumables** app and click on *Install IPAK Meta & Quanta*.
2. Follow the self-guided wizard.

IPAK Meta & IPAK Quanta both need to be replaced at the same time.

This is because they have been designed to achieve the expected best-in-class Milli-Q® ultra-pure water with the unique combination of the proven Jetpore® ion-exchange resin and the innovative IQnano™ resin. *Only together*, and when integrated into the hydraulic design of the system, they can purify water to remove contaminants down to their traces from a pre-treated source.

IPAK Meta & Quanta consumable kit: IPAKKITA1



Note: If the Milli-Q® feed is from a storage tank, before starting, ensure there is at least 30L of water present. If there is not enough water present, the wizard will finish but the cartridges may not be fully rinsed. The remaining rinse will need to be performed manually.

Important! During the physical pack replacement in the water purification unit, both cartridges must first be removed before installing the new set.

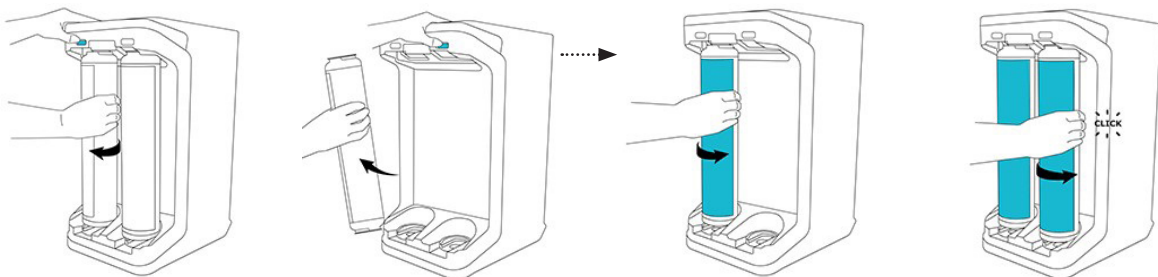

Remove **BOTH** old cartridges

Then insert new cartridges

Note 1: When properly installed, the blue side should face you with the **e-Sure**  symbol behind.

Note 2: If the sound has been activated, it is normal to hear a buzzer when changing the consumables. This is temporary and is only present when the IPAK or POD-Pak are removed. As soon as they are put back into place, the buzzer will stop.

Application POD-Pak installation

1. Select **Install consumables** app and click on *Install application POD-Pak*.
2. Select the POD-Pak to be installed, click on the *Next* button and follow the self-guided wizard.

Do not over tighten the twist & lock action when installing a new POD-Pak.

3. Rinsing must be performed manually to complete the installation as indicated on the screen. When completed press "Finish" to exit the wizard.

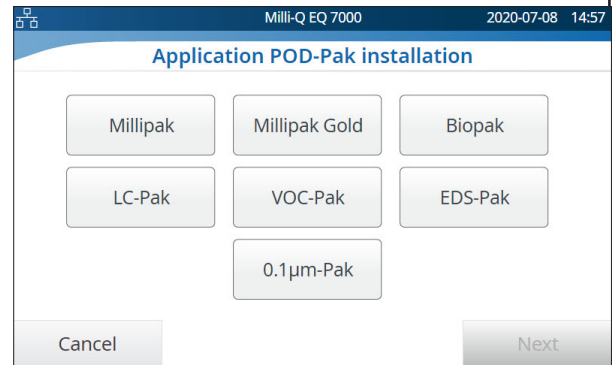

Note: All certificates of quality are now available online.

Visit www.mymilliqconsumables.com

Cleaning & Sanitization

Note: refer to safety addendum for enclosure cleaning (type of substances to be used for a safe cleaning)

Cleaning the inlet strainer

This setting is only available when in a pressurized loop feed configuration.

The purpose of the inlet strainer is to prevent large particles from entering the Milli-Q® system. If the inlet strainer becomes clogged, then feed water does not flow freely to the system. Select **Care/Cleaning** app and click on *Inlet strainer clean*. Follow the self-guided wizards.

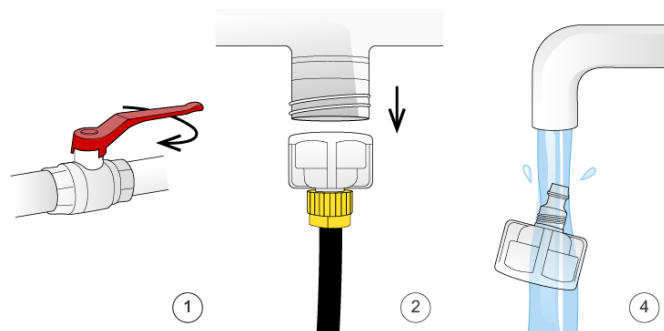

Volumetric dispensing calibration

The purpose of this function is to calibrate the volumetric dispensing function. Calibration shall be performed after each replacement of the cartridges. Regular calibration will ensure accuracy of your dispensing.

Note: You will need a 1.0L graduated cylinder.

Select **Care/Cleaning** app and click on *Volumetric dispensing calibration*. Follow the self-guided wizards.

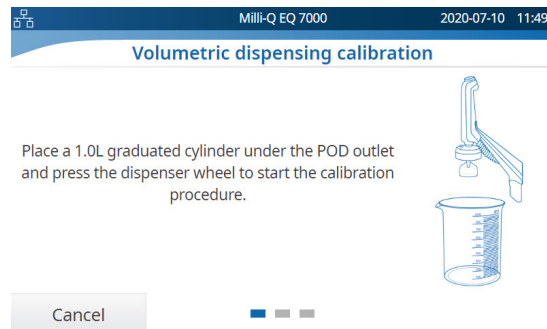

Cleaning the external surfaces

For cleaning and disinfecting the external surfaces of the equipment, use a lint-free cloth wet with one of the following disinfecting agents:

- KLERCIDE™ Isopropanol 70% or equivalent composition
- SPOR-KLENZ® (Ready to use) or equivalent composition

Note that applying any other agent on the surfaces can damage them.

UV lamp

Contact the technical support hotline to organize a replacement visit.

It is highly recommended to have a qualified Milli-Q® field service representative to change the 185/254nm UV lamps. Replacement of the lamps involves removing the panels of the Milli-Q® system.



UV Radiation!
Hazard of illumination will cause eye damage or serious injury.



Hot surface!
Hazard of burning

Important! Never open the system, even when the power switch has been switched off.

It is not sufficient to switch off the system, the plug must be physically removed from its power source. Installation and maintenance should only be done by a qualified person. Appropriate personal protective equipment (PPE) must be worn and safe work practices must be followed.

SELF HELP GUIDE

Depressurize system

Depressurize system in case of water leak to temporarily stop production and all water processes. Go to page 19 [Maintenance > Depressurization](#).

Identify the source of the leak. Once fixed, to exit this mode, a user will need to go back to the home screen on which the initial depressurization took place and select *Exit maintenance* for dispensing to become available again on the Q-POD.

Turn system off

Press the ON/OFF switch located on the left back-side of the unit.

Note: When the system is on, the power switch is lit.

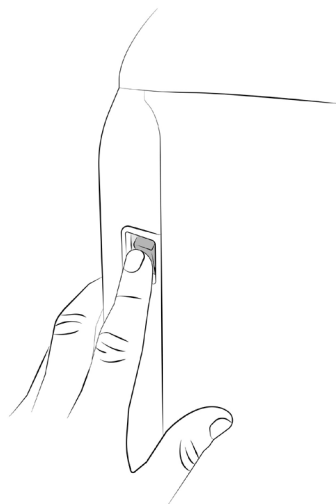

& UNPLUG

Important! Never open the system, even when the power switch has been switched off. Hazardous voltage is present and can cause death or serious injury. It is not sufficient to stop all power to system, the plug must be physically removed from its power source. Installation and maintenance should only be done by a qualified person. Appropriate personal protective equipment (PPE) must be worn and safe work practices must be followed.

If the system is not electrically powered for 20 days or longer, then the date is no longer maintained on its circuit board. If this happens, the date and time need to be reentered., see page 17 [Information>Date Time & Language](#). It takes about 45 minutes to recharge the capacitor.

Inaccurate volumetric dispensing

Volumetric dispensing has been validated to work with a +/- 3% precision. In case of inaccurate volumetric dispensing, go to page 21 [Maintenance>Cleaning & Sanitization](#) for more information.

High TOC values

TOC levels can vary depending on the type of feed water or the laboratory environment. Here are a few recommendations to follow:

A pack replacement can temporarily increase the TOC until they have been completely rinsed out.

Note: There are specific conditions to meet to be able to reach ≤ 5 ppb of TOC.

Low flowrate

- If there is an air-vent on the POD-Pak, ensure the POD-Pak is not air-locked. This can happen in the weeks that follow a replacement of IPAK cartridges. Dispense water and open the POD-Pak air vent to see if there is any trapped air. Close the vent once the air has been released.
- One possible reason for a decrease in Milli-Q® Water flowrate is a clogged POD-Pak. The POD-Pak should be replaced when it appears to be clogged.
- For pressurized loop feed configurations - Check inlet strainer, go to page 21 [Maintenance>Inlet strainer cleaning](#).

IPAK & other cartridges installation

IPAK & other cartridges installation – new cartridges not recognized.

Important! During the physical replacement in the system unit, both cartridges must first be removed before installing the new set.

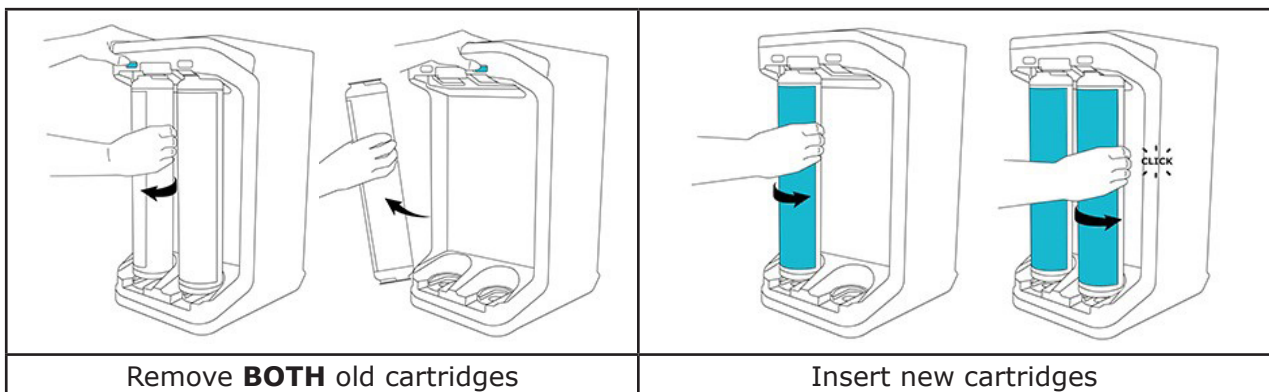



















Check that the e-Sure tag is correctly working. A pre-scan can be initiated by entering into the IPAK Meta & Quanta installation wizard. If the e-Sure tag is working correctly, it will be recognized when scanning the cartridge on the end of the dispenser.

Contact US

Get in contact with the local technical support hotline. The details can be found in the contacts app, go to page 12 [Information >Contacts](#) or visit our website www.sigmaldrich.com

ICONS

Icon	Meaning/Function	Icon	Meaning/Function
	Recirculation		Dispensing
	Volumetric dispensing		System manager logged in
	Start dispense		Stop dispense
	Alarm with number of active alarm(s)		Alert
	Home		Menu
	Storage tank		Back
	Mass storage USB connected		Ethernet - LAN status connected
	Slider ON		Slider OFF
	Password viewer		Calendar entry

REQUIREMENTS AND SPECIFICATIONS

Water specifications

Product Water

When operating within feed water requirements listed in table page 26 [Requirements & Specifications > Water Specifications > Feed Water](#) , the system has been designed to produce water according to following specifications:

Parameter	Value or range
Resistivity	18.2 Mohm.cm @ 25°C
Conductivity	0.055 µS/cm @ 25°C
Total Organic Carbon (TOC)	≤ 5 ppb
Particles (size > 0.22µm)	No particles with size > 0.22µm (with Millipak® filters)
Bacteria	< 0.01 CFU/mL (with Millipak® and Biopak® filters) < 0.005 CFU/mL (with Millipak® Gold installed and used in a laminar flow hood)
Pyrogens (endotoxins)	< 0.001 EU/mL (with Biopak® filter)
RNases	< 2 pg/mL (with Biopak® filter)
DNases	< 5 pg/mL (with Biopak® filter)
Proteases	< 0.15 µg/mL (with Biopak® filter)
Flow rate	up to 2 L/min

The Milli-Q® EQ 7000 system is intended to produce ultrapure water that meets or exceeds requirements as described by the organizations below:

Organization	Water quality / grade
European Pharmacopeia	Purified Water in bulk
U.S. Pharmacopeia	Purified Water in bulk
Japanese Pharmacopeia	Purified Water
Chinese Pharmacopeia	Purified Water
ASTM® D1193	Type I water
ISO® 3696	Grade 1 water
Chinese National Standard	GB 6682 Grade 1 water
JIS K 0557	A4 water
Clinical and Laboratory Standards Institute (CLSI®)	Clinical Laboratory Reagent Water (CLRW)

Feed Water

The system has been designed to operate within feed water requirements below:

Parameter	Value or range
Pressure	< 6 bar (for pressures below 0 bar, the system will operate, but product flow rate may be lower)
Feed water quality	Pretreated water, using EDI, DI, RO or distillation technologies without added chemicals
Temperature	5 - 35°C (41 - 95°F)
Conductivity	< 50 µS/cm @25° C (FCE)
Total Organic Carbon (TOC)	< 50 ppb

IMPORTANT! When the feed water source (loop or tank) is being sanitized, make sure that the feed water supply valve is closed or the water system powered off.

System specifications

Electrical

The power supply converts mains voltage to 28 V. The power supply is compatible worldwide.

Catalog	Frequency	Max power	Voltage
ZEQ7000T0 & ZEQ7000T0C & ZEQ7000TR	50-60 Hz ±2Hz	170 VA	100 – 240 Vac ± 10%

Environmental

Specific environmental conditions have to be respected to ensure normal operation of the Milli-Q® system.

Location	indoor use only
Ambient operating temperature	room temperature ranges from 4°C to 40°C
Relative humidity	maximum relative humidity of 80% for a temperature up to 31°C, decreasing linearly to a relative humidity of 50% at 40°C
Altitude	up to 3000m above sea level
Installation category	bench / underbench or wall mounted
Pollution degree	2
Noise level	< 50 dB at 1m

Communication

The HMI has a large HD capacitive 7" touch screen (Resolution: 800*480) that allows control and monitoring of the system.

USB

The HMI has a built-in USB port that offers the possibility to export the system data and/or history. The Host interface is compliant with the USB 2.0 Highspeed standard.

USB keys only work when formatted FAT32. NTFS format is not compatible.

Ethernet

When connected through an Ethernet protocol, the display interface can be accessed remotely using internet web browsers.

For best browsing performance, the recommended browser is Chrome®.

System software

System software included in this product contains copyrighted software that is licensed under the GNU GPL.

The legal notices are available in the HMI display: Information menu > System app > Legal Notices

Dimensions and weight

Bench solution

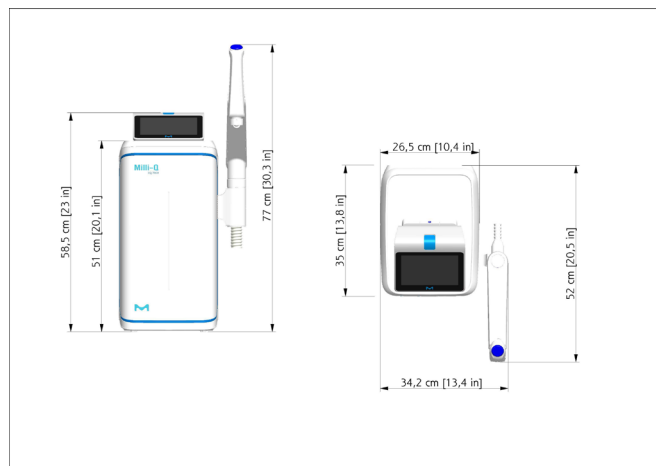

Wall-mounted solution

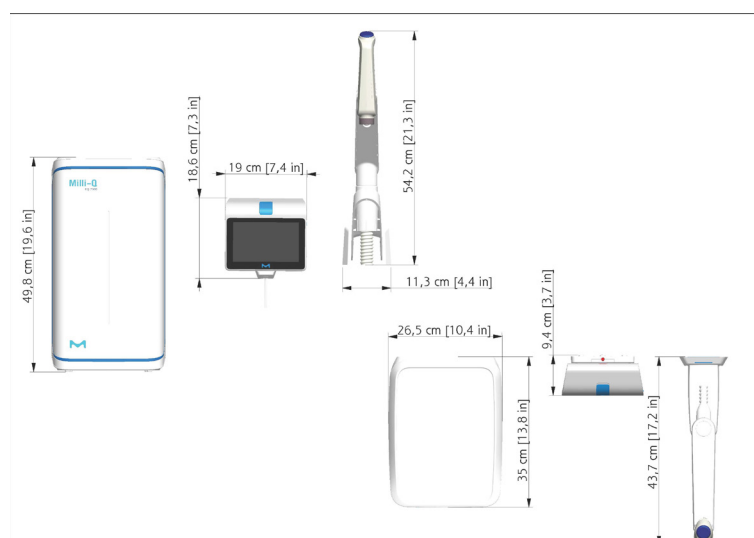

System Type	Dry weight	Shipping weight	Operating weight
Water purification unit (on a bench)	14.0 kg (30.9 lb)	15,6 kg (34.4 lb)	18,0 kg (39.7 lb)
Water purification unit (wall-mounted)	12.0 kg (26.5 lb)	15,6 kg (34.4 lb)	16,7 kg (36.8 lb)
Q-POD dispenser (wall-mounted)	1.2 kg (2.7 lb)	1,5 kg (3.3 lb)	1.2 kg (2.7 lb)
HMI (wall-mounted)	0.58 kg (1.3 lb)	0,67 kg (1.5 lb)	0.58 kg (1.3 lb)

Dry Weight is defined as a system without its shipping container. Consumables and accessories are not included.

Shipping Weight is defined as a dry system in its shipping container. Consumables and accessories are not included.

Operating weight is defined as a wetted system with all its consumables, but not any accessories.

Note: For wall mounting installation , use a concrete wall capable of support max load of 16 Kg. Use 6mm diameter stud and fasteners capable to support max load of 4 Kg each.



Recycling

Directive 2012/19/UE:

For European users only

The symbol "crossed bin" on a product or its packaging indicates that the product should not be treated like household waste when discarded. Instead the product should be disposed of at a location that handles discarded electric or electronic equipment.

Proper disposal of equipment containing electric or electronic components will help to reduce pollution effects to the environment or to human health. Proper recycling of these products helps in environmental preservation and helps to protect natural resources. For more information about recycling of products containing electric or electronic components, please contact your local recycling representative or organization.

Ordering Information

Accessories

Name	Catalog Number
Wall-mounting Q-POD solution	WMEQ0RKT
Wall-mounting HMI solution	WMEQ0DKT
Bench Top Q-POD solution	SMEQ00KT
Bench Top HMI solution	BTEQ0DKT
System wall mounting bracket	SYSTFIXA1
Water sensor	ZWATSENA1
Foot pedal	ZEQ7FTPDL
Internal Pressure Regulator + Feed conductivity cell	ZEQ7C0NDC
Internal Pressure Regulator	ZF3000810
e-Sure dispenser tip	ZFDISTPA1
Alarm relay cable	ZMQ0ALCA1

Consumables – order at www.mymilliqconsumables.com

Description	Catalog Number
IPAK Meta® & IPAK Quanta® consumable kit	IPAKKITA1
Millipak® 0.22µm filter	MPGP002A1
Millipak® Gold 0.22µm sterile filter	MPGPG02A1
Biopak® polisher	CDUFBI0A1
LC-Pak® polisher	LCPAK00A1
EDS-Pak® polisher	EDSPAK0A1
VOC-Pak® polisher	V0CPAK0A1
UV Lamp	ZEQ7UVLP0

LEGAL INFORMATION & WARRANTY

It has always been Millipore SAS policy to continuously improve its products.

The information in this document is subject to change without notice and should not be construed as a commitment by Millipore SAS. Millipore SAS assumes no responsibility for any errors that might appear in this document. This user manual is believed to be complete and accurate at the time of publication. In no event shall Millipore SAS be liable for incidental or consequential damages in connection with or arising from the use of this user manual.

Product warranty and limitation of liability

The applicable warranty and limitation of liability for the products listed in this publication may be found at www.sigmaaldrich.com within the "Conditions of Sale" applicable to your purchase transaction.

Copyright

© Millipore SAS 2016.

All rights reserved. This document or parts thereof may not be reproduced in any form without the written permission of Millipore SAS.

The photographs illustrating the products are non-contractual.

Trademarks

The initial M, Millipore, Milli-Q, Q-POD, IPAK Meta, IPAK Quanta, Jetpore, IQnano, Millipak, Biopak, EDS-Pak, VOC-Pak and LC-Pak are trademarks of Merck KGaA, Darmstadt, Germany.

Millipore SAS is an affiliate of Merck KGaA, Darmstadt, Germany.

All other trademarks are trademarks of their respective manufacturers.

The Life Science Business of Merck KGaA, Darmstadt, Germany operates as MilliporeSigma in the US and Canada.

Safety information: Please refer to Safety Addendum

Your Milli-Q[®] system should be operated according to the instructions in this user manual. In particular, the hydraulic and electrical specifications should be followed and met. It is important to use this equipment as specified in this manual; using this equipment in a different manner may impair the safety precautions of the Milli-Q[®] System.

Never open the system, even when the power switch has been switched off. Hazardous voltage is present with a hazard of electrical arc flash. Will cause death or serious injury. It is not sufficient to stop all power to system, the plug must be physically removed from its power source. Installation and maintenance should only be done by a qualified person. Appropriate personal protective equipment (PPE) must be worn and safe work practices must be followed.

Document Reference: mk-um-milli-q-eq-7000-en

Revision: V3.0



WolfLabs

Pricing on any accessories shown can be found by keying the part number into the search box on our website.

The specifications listed in this brochure are subject to change by the manufacturer and therefore cannot be guaranteed to be correct. If there are aspects of the specification that must be guaranteed, please provide these to our sales team so that details can be confirmed.

www.wolflabs.co.uk

Tel : 01759 301142

Fax : 01759 301143

sales@wolflabs.co.uk

Please contact us if this literature doesn't answer all your questions.